

Surf League

MANUAL



Warning

- ✧ Please read the manual before installation and use.
- ✧ Please put the manual together with the machine.



ACE AMUSEMENT

ACE Amusement Technologies Co., Ltd.

ADD: #5 Building, No. 6, HengFeng 6th Road,
Gangkou Town, Zhongshan City, Guangdong,
P. R. China PC: 528447

TEL: (+86) 760 8848 8920

E-Mail: Sales@ACE-Amusement.com

Web: www.ACE-Amusement.com

CONTENTS

Features of the Product:	3
Specifications and Technical Parameters	3
Accessory list	4
How to Move and Position the Machine	5
How to Move the Machine	5
How to Position the Machine	5
Unsuitable places	5
Installation Location Dimension	6
Wiring and Precautions	6
Game Introduction	7
Game interface	7
Game features	7
Game Scenes	8
Game play:	8
Game background Settings	10
Correction Settings	11
Parameter and Assembly Steps	13
Fault Analysis and Troubleshooting	14
Error Prompt	16
Instructions on Restoring U Disk	17

Features of the Product:

"Surf League" is a newly developed indoor high-end surfing simulation machine of our company, the unique surfing theme shape beautiful atmosphere, reasonable ergonomic design allows players to better combine the game, and feel the immersive fun, at the same time is the playground high revenue of entertainment products.

Small mechanical products;

The game play is novel, exciting, man-machine interaction, extremely rich leisure and entertainment;

The appearance design is beautiful and generous, bright, delicate, solid materials;

Using integrated circuit, built-in program, stable working performance, safe and reliable;

Adapt to the generic type lottery;

Using an independent computer host control, stable and reliable.

Specifications and Technical Parameters

- 1) Operating Voltage: AC 220V - 240V, 50/60 Hz or AC110V \pm 5%, 50/60 Hz;
- 2) Maximum Power: 450W
- 3) Dimensions: W1590 \times D1910 \times H2340(mm)
- 4) Weight : 450kg
- 5) Operating Environment:
- 6) Temperature (indoors): 0 $^{\circ}$ C \sim 35 $^{\circ}$ C;
- 7) Humidity: \leq 90%;
- 8) Atmospheric pressure: 86Pa \sim 106Pa.







Warning: After turning off the machine, please wait 1 minute if you want to turn it on again.

Accessory list

For the normal use of the machine, please open the package and carefully check whether the following items are included.

The accessory list is below:

Name	Unit	QTY	Picture	Remark
Manual	Pc	1		Surf League
Cable	Pc	1		
Fuse 10A	Pc	5		
AA32 Key	Pc	2		
AA33 Key	Pc	2		

Please open the package and check whether all accessories are included. If not, please contact the distributor of the machine for check.

How to Move and Position the Machine

How to Move the Machine

There are trundles under the machine. When moving the machine for a short distance, you should raise foot to make the trundles touch the ground and push the machine. As there will be danger of overturning when the foot hits obstacle on the ground, you should move the foot up as much as you can and pay attention to obstacles ahead and uneven places when moving the machine along the ground.

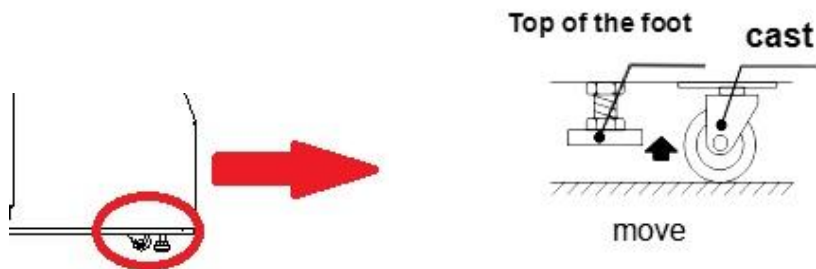

How to Position the Machine

- Please place it on flat ground where it won't slide easily;
- Please use the following foot to fix the machine (as shown below)
 - ① Loosen the tightly locked nuts of the foot, tighten the bolts of the foot with a wrench, and keep the trundle approximately 5mm away from the ground.
 - ② Tighten the nuts clockwise and fix them.

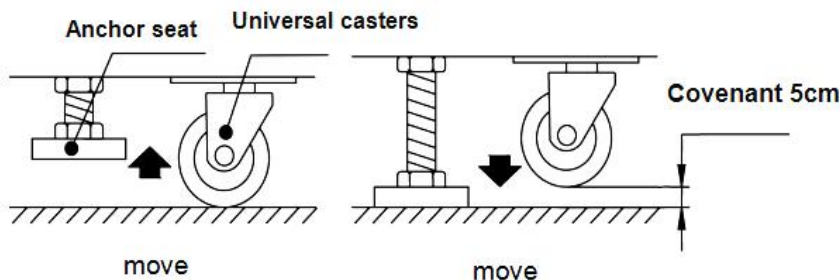

Unsuitable places

- Place in which the machine may have condensate water or with high humidity;
- Place close to high-temperature objects;
- Place close to dangerous substances;
- Smooth or unstable place;
- Place close to equipment that may easily produce sparks;

- Place with heavy vibration;
- Dusty place.



ATTENTION

Please unplug the power socket before moving to prevent accidents and failure.

Please do not damage the cable when moving to prevent accidents and failure.

Please move the machine before raising the foot margin as much as you can to prevent accidents and failure.

The machine shall be moved by at least two people to prevent injury caused by the accident.

Installation Location Dimension

The machine should be placed according to the following dimensions for customers' safety and enough space to run the machine. Game Area:

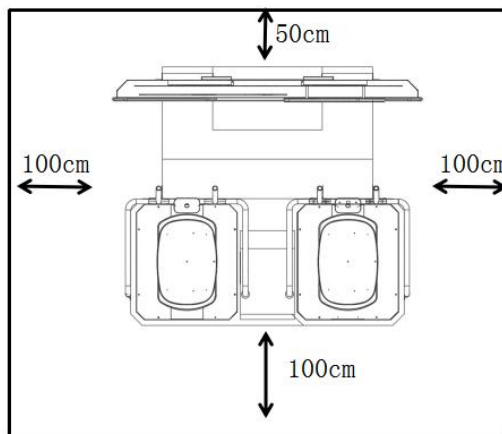

Wiring and Precautions

- Connect one end of the cable to the terminal box of the machine, and connect the other end to the socket.
- Connect the power supply according to the voltage on the label, or the machine might be damaged.
- Please confirm whether there is grounding in the socket to avoid unnecessary damage.
- If the grounding cannot be done through the socket, please try other methods.

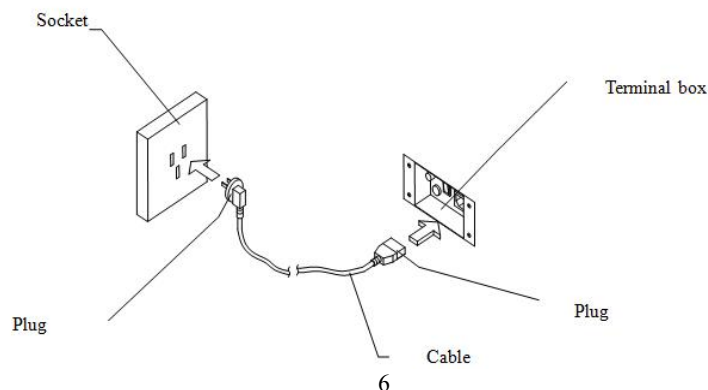

Game Introduction



Game logo/standby image

Game interface



1. **Player score:** Displays the points that the player currently receives
2. **Players ranking:** Show the player's current ranking score: show the value of the player's reward after hitting the line
3. **Game time:** displays the player's current remaining time
4. **Player speed:** Displays the current player
5. **Obstacles:** When the player hits an obstacle, he gets injured and slows down
6. **Props:** Players can get points when they pass the item, or perform a fancy performance

Game features

1. Scene map in the game is divided into four scenes, sea port, city, water city and ice and snow scene.
2. There are also some hidden acceleration items in the scene that can create a very exciting chase feel.
3. Players face a variety of obstacles, as well as a variety of jumping platforms, the player's freshness and tension will be stronger.
4. There are a variety of items in the game, so that players have a great challenge speed and different fun.

Game Scenes

Free harbor



Water city



Silent city



Frozen zone



Game play:

1. Choose the game mode

There are two single player mode and two player mode.



2. Role selection

Players can choose their favorite characters to play, and there are five different characters to choose from



3. Choose the scene

Players can choose from different maps, with four maps to choose from



4. Enter the game

After entering the game, players need to control the direction to avoid obstacles, pick up score items through the platform and other props can also be fancy air performance, pick up special items to continue to draw, there will be more surprise rewards! The higher the score after the game, the more lottery tickets are awarded.



5. Complete the game and make the settlement

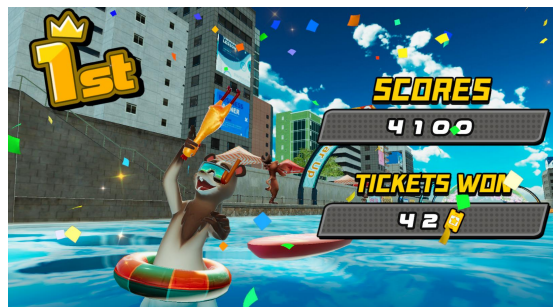

Game background Settings

Main Menu

- 1、 Basic Setting: Enter the Basic Settings interface
- 2、 Input Test: Enter the input test interface
- 3、 Output Test: Enter the output test interface
- 4、 Adjust Setting: Enter the correction 1P with the 2P potentiometer
- 5、 Game Reset: Enter the game reset interface
- 6、 Date /Time setting: Go to the date / time setting interface
- 7、 Revenue Record: Enter the revenue record interface
- 8、 Certificate renewal: Renewal the trial version
- 9、 Save & Exit: Save the modified settings and return to the game interface
- 10、 Exit: Do not save the modified settings and return to the game interface

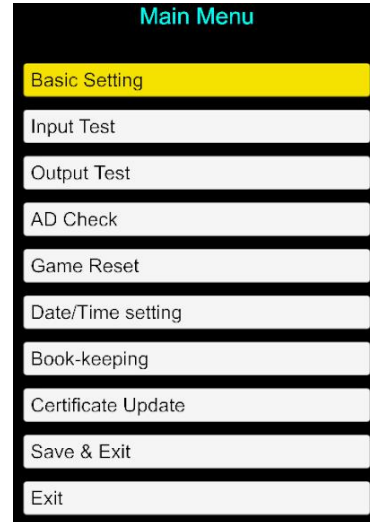

Basic Settings

- 1、 Volume: Set the game volume
Range: 0%~100% (Default 100%)
- 2、 Standby volume: set the standby music volume
Range: 0%~100% (Default 100%)
- 3、 Game Coins: set the number of coins required for the start of each game
Range: 1~ / 100 free (default 3)
- 4、 Logo Enable:
Open the game standby display trademark
Close: not shown
Open: display
- 5、 Ticket Enable: choose whether to issue the lottery ticket
No: no lottery tickets
Yes: lottery tickets
- 6、 Game time: Set up the time of each game
Range: 60-300 (default: 120 seconds)
- 7、 Player moves speed: Set the speed of the player's paddle
Range: Low speed, medium speed, high speed (default medium speed)
- 8、 Scores for the ticket: Set how many points to redeem for one vote
Range: 100 to 5000 (default 300)
- 9、 Return: Return to the previous level menu

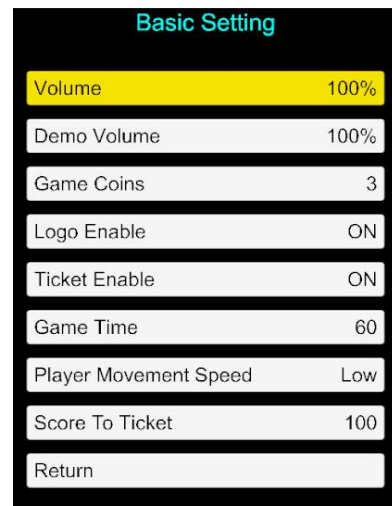

Enter Testing

- 1、 1P insert coins: Test the 1P coin
Close: No coin
Open: coin
- 2、 2P insert coins: Test the 2P coin
Close: No coin
Open: coin
- 3、 1P Start the button: Test the 1P Start button
Close: No press
Open: press
- 4、 2P Start the button: Test the 2P Start button
Close: No press
Open: press
- 5、 1P potentiometer X: Test the 1P potentiometer X
- 6、 2P potentiometer X: Test the 2P potentiometer X
- 7、 Return: Return to the previous level menu

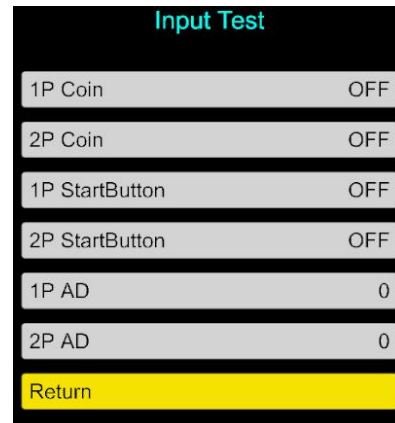

Output Testing

- 1、 Ticket test: Ticket issue test (on / off)
- 2、 Horn lamp: Speaker light (on / off)
- 3、 Display lamp: Display light (on / off)
- 4、 Base lamp: Base lamp(on / off)
- 5、 Start the button light: Start the button light (on / off)
- 6、 Skateboarding lamp: Skateboarding lamp ((on / off)
- 7、 Ground lamp: Ground lamp(on / off)
- 8、 Small control desk lamp: Small control desk lamp(on / off)
- 9、 Vibration motor: Vibration motor(on / off)
- 10、 Console unlock: Test whether the skateboard unlocking function is normal
- 11、 Lock on the console: Test whether the locking function of the skateboard is normal
- 12、 1P Unlocks Light Eye: 1P Unlocks Light Eye(on / off)
- 13、 2P Unlocks Light Eye: 2P Unlocks Light Eye(on / off)
- 14、 Return: Return to the previous level menu

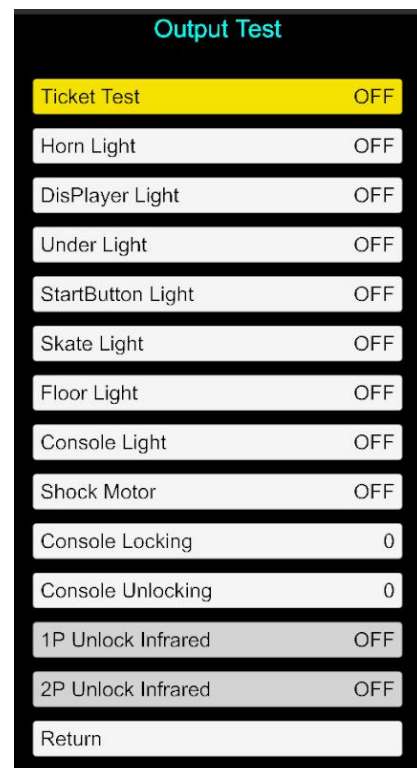

Correction Settings

- 1、 1P correction: 1:Turn the pedal to the far left and press the confirmation button.

- 2P correction: 2: Turn the pedal to the far left and press the confirmation button.
3. Return: Return to the previous level menu

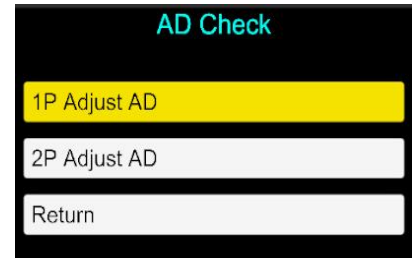

Game Reset

1. Restore to the factory settings: Put all the data in the game, and the settings are restored to the default
2. Clear all data records: put all numbers of the game Record it back to the default
3. Clear the owed votes: clear the owed votes
4. Clear the number of unused coins: Clear the number of unused coins
5. Return: Return to the previous level menu

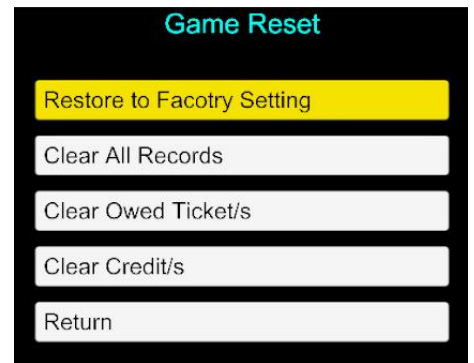

Date / Time Setting Book-keeping



Player	Coins	Tickets	Ticket Rate
1P	54	324	6.00
2P	3	0	0.00
Total	57	324	5.68

Date	Week	Time	Coins	Tickets	Ticket Rate
2023-07-18	TUE	01H:44M	27	324	12.00
2023-07-17	Mon	00H:18M	0	0	0.00
2023-07-14	FRI	00H:28M	30	0	0.00

P1/1

Certificate renewal

1. Renewal the trial version

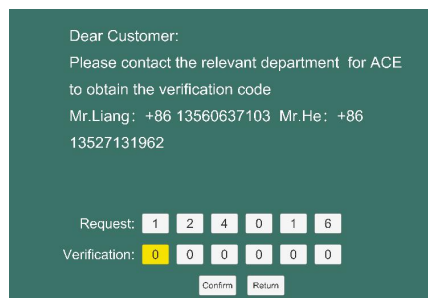

2. Save & exit
3. Back

Parameter and Assembly Steps

1 Installation and Commissioning

Please check the components according to the list to assemble components before installation;

After installation, plug the cable and turn on the machine to check whether each part runs normally. If no, immediately turn off the machine for troubleshooting.

2. Appearance Inspection

To ensure the safe use of the machine, please check the following before startup:

Whether the warning sign is intact, visible and stuck correctly.

Whether parameters of power supply are consistent with the requirements of the machine.

Whether screws of each component and components of the steering wheel are loose.

Whether the connectors and terminals are loose.

Whether the machine is placed stably; whether the adjustment of the casters and the top foot are proper.

Whether the machine is placed in the proper area.

3. Running Inspection

Whether the speaker works normally.

Whether the daylight lamp and the button light are on.

Whether the image is clear and normal.

4 Maintenance

Before operation, test run must be done before the machine is used;

When there is dirt on the machine, wipe it with a soft cotton cloth with detergent;

After the new machine has been used for one month, check whether each part runs normally;

Often check the machine;

The machine must be cleaned and maintained once a month.

Fault Analysis and Troubleshooting

Common faults

Fault phenomena	Main cause	Corrective action
After the machine is powered on,(the power supply fan works), but the display is not on.	The monitor is not energized.	Please reconnect the power cable or replace it with new.
	The signal wire of the display is not connected or damaged.	Please reconnect the signal wire or replace it with new.
After the machine is powered on, nothing happens and the screen is not lit.	The power supply is inconsistent with the machine's parameters.	Please check whether the power supply is consistent with the machine's parameters.
	Fuse is burnt out.	Please replace the fuse.
	The power supply is not connected.	Please confirm 110V~220V power supply is connected and the power switch is on
	The signal wire of the display is not connected or damaged.	The signal wire of the display is not connected or damaged.
The machine is not powered on.	Check whether the input of the 110V~220V power supply is right. The short circuit is not allowed.	Please check whether the voltage of the circuit board inside the machine is abnormal.
The control panel is not powered on	Check whether the output of 12V of the power supply box is normal.	Please adjust the cable to the correct position.
The display has no raster.	The cable of the display might fall off or be loosen due to vibration.	Please check the power supply circuit or replace the power line.
	The display is not on..	Turn on the machine again manually.
The power is off on the midway.	The circuit protector generates an action and the power switch is turned off (Note: The circuit protector cuts off the current when the abnormal current flows).	Please turn on the power switch again. When the circuit protector repetitively acts, it indicates that the machine is abnormal. Please contact the dealership.
After the product is powered on, the display is a white screen without any image or sound.	The host machine does not work.	Manually start the power start button of the host machine.
		The host power is bad or replaced.
		The motherboard memory bank is bad or replaced.
		The motherboard is bad. Please contact professional and manufacturer.
Pressing start key cannot start the game.	The start button holder is loose, and the switch line is loose.	The button holder is broken or replaced, the switch wire is pressed, and the start button switch is broken or replaced.
No response to coin	The coin collector is damaged.	Replace coin collector.

collector.	The signal line of the coin collector is loose.	Check if the signal line of the coin collector is loose.
	IO control board is damaged.	Replace IO control board.
Coins are blocked in the coin collector	The sample coin is not placed well.	Please check whether the sample coin is placed well, or try another sample coin.
	The coin slot is not aligned or deformed.	Please check whether the coin slot is aligned or deformed, and adjust coin slot.
	The coin collector is not assembled properly. The red braking bar above the coin collector is pressed.	Please re-insert it into the coin collector.
The coin collector does not score.	Check whether there is signal feedback.	Please re-connect the coin collector. It will make a sound if there is signal.
	The connected target board is not connected to the pull-up resistor.	Please connect the pull-up resistor.
	Check whether the token in the coin collector is the same with that inserted in the coin collector.	Please replace it with the proper token.
	The gear of the switch (normally on and normally off) is incorrect	Please check whether the gear of the switch (normally on, normally off) is correct.
	The socket outlet of the coin connector is in poor contact.	Please check whether the socket outlet of the coin connector is in poor contact.
The speaker does not make a sound.	Whether the circuit board of the power amplifier is powered on.	Please turn on the switch of the amplifier circuit board to power on
	The volume is too low.	Please turn the volume up.
	Whether the audio connection port falls off or is damaged.	Please re-connect the audio connection port.
	The circuit board of the power amplifier goes wrong.	Please replace the circuit board.
	The speaker goes wrong.	Please replace the speaker.
No lottery fed.	The ticket machine goes wrong or the switch is turned on wrongly.	Please replace the ticket machine or set the switch to the factory settings.
Shooting is not accurate.	Check if the potentiometer of the gun is damaged.	Replace the potentiometer and re-align the gun.
No prize is out.	The prize machine goes wrong or the switch is turned on wrongly.	Please replace the prize machine or set the switch to the factory settings.

Error Prompt

1. **Cause: Disconnection with the IO board**

Solution: Restart the machine, and press the reset button on the IO board (there is only one button on the board)



2. **Cause: No enough tickets, or the ticket machine is damaged**

Solution: Replenish ticket; replace the ticket machine

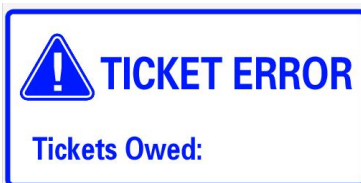

3. **Cause: The memory of the host is insufficient**

Solution: Plug out the memory of the host, and then plug it in again.



! Warning:

● **Cut off the power supply for maintenance and repair of the machine.**

To prevent short circuit, relevant personnel should cut off the power supply when touching internal components of the machine. If the operation requires power supply, it should meet the requirements of the manual.

● **Use proper parts for replacement.**

Improper parts may cause short circuit, and damage of the main board and the components.

● **Do not disassemble, assemble and change the equipment randomly.**

It may cause short circuit and machine failure, and even fire disaster.

● **Do not place vases, cups and containers with water, chemicals or heavy objects on the machine.**

The spilt liquid may cause short circuit and damage of parts. Meanwhile, falling objects may injure people and damage the machine.

● **Do not place objects in the exhaust outlet of the machine.**

- The blocked exhaust **outlet** may cause temperature rise inside the machine, affect the normal operation of the game, and even damage the parts.

➤ **Do not repair the machine by yourself.**

Instructions on Restoring U Disk

When the machine is turned off, plug the U disk into the USB port behind the host, and the U disk will restore after the machine restarts. As shown in the figure, the system is restoring, and it needs about 20 minutes.

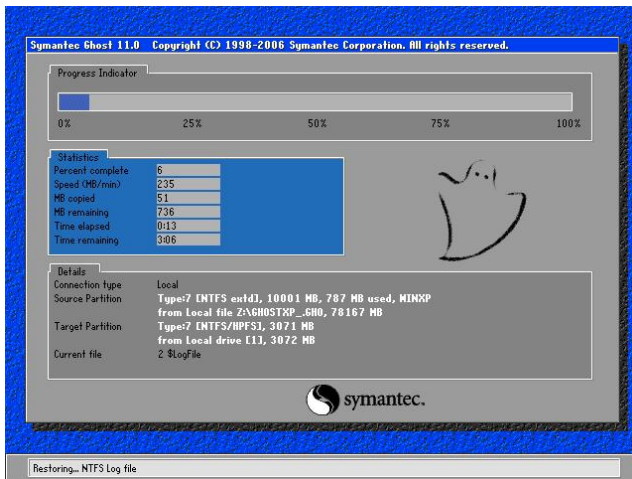

Complete prompt. The system restoring is completed as shown in the left figure, and you can unplug the U disk.

The system restoring needs about 20 minutes. Please do not cut off the power supply and wait patiently! Please forgive if there is any inconvenience!



Attention:

The above technical parameters are subject to change without prior notice.



ACE AMUSEMENT

ACE Amusement Technologies Co., Ltd.

ADD: #5 Building, No. 6, HengFeng 6th Road,
Gangkou Town, Zhongshan City, Guangdong,
P. R. China PC: 528447

TEL: (+86) 760 8848 8920

E-Mail: Sales@ACE-Amusement.com

Web: www.ACE-Amusement.com