



COMBOBOXER

Punch-Force measuring machine

Technical Information



Index:

1. Introduction.....	3
2. Usage/Purpose	3
3. Technical Data	4
4. Assembly/ Construction description.....	4
5. Transport.....	6
6. Installation	6
7. Usage instructions.....	7
8. Maintenance check list, problem prevention and day-to-day conservation	9
9. Quick check for potential errors	13
10. Machine setup	17
11. Spare parts and equipment.....	43
12. Standard replacement parts	43
13. Required tools and equipment for servicing the boxing game	43
14. Step by step setup and maintenance instructions.....	44

1. Introduction

Main purpose of this Technical Information is to:

- familiarize user with machine construction,
- provide proper setup parameters, installation and power line hookup,
- familiarize user with proper and safe usage procedures, exploitation and conservation.



WARNING!

**USER MUST FOLLOW ALL
GUIDELINES INCLUDED IN THIS
DOCUMENT FOR SAFE AND LONG
LASTING MACHINE USAGE.**

2. Usage/Purpose

Comboboxer is a punch-force and kick-force measuring machine. The machine is designed to allow players to choose between two game types: boxing and kicking.

This machine allows to measure punch-force (boxing power game), kick-force (kicker power game) and play a power tournament game between up to 6 players, either as a boxing game or kicking game.

Comboboxers can be placed in night clubs, gyms, bars etc., generating tons of positive fun and allowing players to check/measure their boxing skills or their

kicking skills. Complete and detailed usage instructions are under paragraph 7 of this document and on the sticker placed on each machine.

3. Technical Data

Model	COMBOBOXER
Depth [in]	51
Width [in]	36
Height [in]	90
Overall Mass [Lb]	351
Power consumption [Wh]	200

4. Assembly/ Construction description

Punch-force and kick-force measuring machine Comboboxer is built out of three main components:

- base,
- middle assembly,
- top assembly.

The key component is a mother board (electronic board) placed inside Boxer's body (block schematics drawing #1) to which mechanical elements and user interface components are connected.

Electric/ electronic part contains following:

- power supply (drawing #4 and drawing #5) – consists of transformer, fuses and broadcasters that control alarm sirens &

electromagnet – transforms voltage from 110 V to 12 V (connected to main board J6),

- measuring mechanism – consists of sending and receiving diodes that measure blade fly speed through assembly,
- verbal information mechanism – built using potentiometer and speaker, used to send voice messages,
- punching bag lowering mechanism – consists of button START with backlight and electromagnets – actual lowering mechanism,
- kicking ball lowering mechanism – consists of button START with backlight and electromagnets – actual lowering mechanism,
- visual information assembly – assembled out of diodes used for visual representation of punch force measurement, warning siren (informs player of breaking top record) also displays on electronic panel (shows measurement result, credit amount, top day record),
- coin acceptor – used to deposit coins (can be reprogrammed to tokens or other currencies),
- bill acceptor – used to deposit bills (optional),
- mother board.

5. Transport

Machine should be transported in vertical position. Machines are shipped on a wooden 41" x 53" pallet, and sides are covered with special thick (~3/8") multi-layer cardboard 93" tall (from the bottom of the pallet). The total weight of the box is approx. 491 lbs.

After machine is taken out of the box, it should be transported in horizontal position with the help of two wheels. Machine can, in special cases (exp. if it does not fit in doorway), be taken apart and then reassembled. This procedure should be done by a specialist or someone familiar with all technical information.

6. Installation

Machine, after being taken out of the box, should be placed in vertical position and the base should be leveled. To level the machine correct tools should be used (exp. laser level or typical manual construction heavy duty level). Turning several screws under the base allows for level adjustment. After plugging the machine to grounded power outlet it should be ready to use. Please note, machine placed outdoor **MUST** be connected to grounded GFCI type power outlet.

Make sure that there is enough clearance on the sides and in front of the machine, so the player will not hit any objects or person after punching the bag. Recommended safety radial distance is 5 feet from the point where the bag drops to the lower position. Make sure that machine is not accessible from it's back to anyone while played. The **installer** of the machine is responsible for defining the safe clearance.

7. Usage instructions

- a) It is recommended to use warm up punches before the maximum strength punch.
- b) For the first time user, please practice with several easy test punches before your maximum punch.
- c) Read the user instructions placed on the machine,
- d) Select type of game (default setting is power mode for both, the boxing and the kicking game) by pressing PLAYERS button located on the main

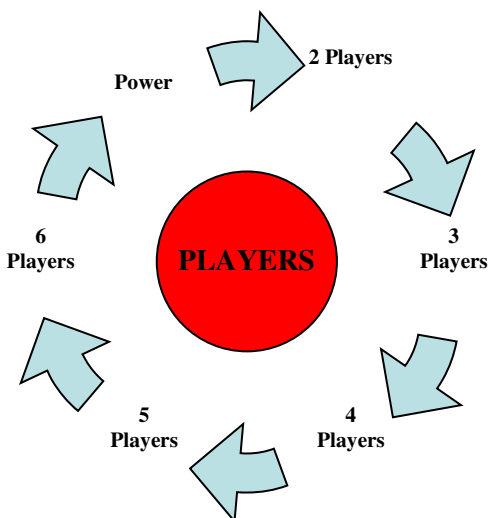

body of the game. Player can choose between following types of game: power, tournament for 2 players, tournament for 3 players, tournament for 4 players, tournament for 5 players, tournament for 6 players. Pressing the PLAYERS button will cycle through the available modes as illustrated in the diagram above.

- e) Before pressing the START button player must stand in front of the Comboboxer.
- f) Start game (Boxer or Kicker/Soccer) by either pushing ‘START BOXING’ (for Boxer) or ‘START KICKING’ (for Kicker/Soccer) button.
- g) After pressing one of the START buttons player has to wait in front of the machine for the punching bag to be released from the upper position (for Boxer) or for the kicking ball to be released from the blocked position (for Soccer).
- h) (For Boxer) After the punching bag is released, player should make a fist so the thumb would be on the outside of the pointing and the middle finger.
- i) The punch/ kick must be placed in the center of the punching bag/ kicking ball.
- j) After the punch/kick, a score would be displayed on the front panel.
- k) Follow the same instructions before the next game.

8. Maintenance check list, problem prevention and day-to-day conservation

Every two weeks (recommended):

- check the air pressure of the bag and the ball - it should be **NO MORE** than 2psi, no less than 1.5psi,
- check if the bag is not rotating about its own axis. If it is, see point D in this section,
- check the position of the arm protectors – boxer and kicker (see point H in this section),
- check all of the connections on the main board,
- check the level/ balance of the machine (if needed, use adjusting legs under the machine to bring the machine to level),
- check if the usage instructions and disclaimers are readable.

Every month:

- check mounting cover screws/nuts,
- check the lubrication of the mechanism (for instructions see point C in this section),
- check the display lights,
- clean the bill acceptor (if installed).

Every two months or 1000 punches:

- check the clearance on the Kicker/Soccer arm,
- check the bumper.

A) Coin acceptor maintenance

Coin acceptor should be cleaned periodically (every 2000 - 3000 credits). Best way to clean it is by using simple cloth slightly soaked in distilled alcohol. Focus should be placed on cleaning the area where coins slide

through (make sure sliding part is in open position).

B) Sound volume regulation

R362 potentiometer (see drawing #1) used to control volume is placed on the right side of the electronic board. The volume adjustment can be done by rotating the potentiometer to the left or right.

C) Maintenance of mechanism and regulating spring

Periodically (once a month or more often, or if the lowering speed of punching bag or kicking ball is fairly low) all moving elements should be rubbed/ sprayed with WD-40 or grease.

If punching bag or kicking ball lowers slowly or too fast one should check if spring is properly stretched. Spring can be adjusted with screw that is in the front left side after taking the masking net.

In case of forced lowering mechanism replacement one should unscrew plastic casing, and then take off masking board (black from the bottom) and remember about the retro cop light.

D) Manual punching bag reposition

In case the punching bag is vibrating too much (or if it is rotating around its own axis), the top nut located on the punching bag screw should be tightened (loosen the lower nut first) until the bag is not rotating any more.

E) Replacement of inner punch bag bladder

To replace inner bladder of the punch bag or kicking ball one should untie rope, take out old insert and replace it with a new rubber bladder. A special

attention must be paid to the location of the bladder valve. The valve must be placed in the opening of the leather cover.

F) Bulb replacement, PLAYER button

In case of bulb failure in the GAME button one should take out micro-switch from the casing (by slight turn and then pull) and then proceed with bulb replacement [bulb spec: 12 Volt & 5 Watt]. If your machine has Bi-LED lights, the specs are: 12V & 1W.

G) Fuse replacement

Machine is equipped with two long term fuses. One at power supply assembly and the second one on the main electronic board [specs: 230V & 4 A]. In case of short circuit situation and/or insufficient power supplied to the electronic main board one should first check the fuses and if they are burned, then proceed with replacement. Make sure fuses used to replace old one have the same specifications.

H) Position of the Arm protector

DO NOT PLAY THE GAME WITHOUT PROPERLY PLACED ARM PROTECTOR.

The position of the arm protector should be like on the picture below (1 – boxer, 2 - kicker):



1

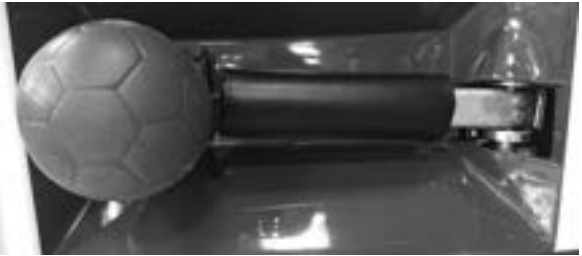

2

The following two pictures illustrate an improper setup of the arm protectors. NEVER leave the machine in this state. The picture on the left shows the arm protector placed too high. The second picture shows the missing arm protector. Both of these cases may result in serious injury to the user.



9. Quick check for potential errors

All the tests and repairs have to be done by service workers authorized by the manufacturer. Ask your supplier for assistance.



Main board is not functioning:

- 1 Check all fuses (5A).
- 2 Check the connection between main power supply and the main board.
- 3 Make sure that the main processor and other connectors are well seated.
- 4 All displays can be checked by turning the switch #1 to “ON” position than turning machine off and back on.

Coin Acceptor is not functioning:

- 1 Check if it is not clogged up.
- 2 Check for dust and dirt.
- 3 Check the ribbon cable connecting the main board with the acceptor.

Mechanism is not functioning:

- 1 Using just power supply check if it is possible to lower punching bag (using manual switch, black button above the 12V connector - see drawing #4 or drawing #5).
- 2 Check for burned fuse 30A.
- 3 Check buttons functionality and if they have proper connection.
- 4 Check for unhooked cable from power supply spools.

- 5 Check ribbon cable connecting the main board with the power supply.

Sensor is not functioning:

- 1 Check sensors in service mode (first press “START BOXING” [when checking Boxer] or press “START KICKING” [when checking Kicker/Soccer] and use switch #1 on the main board (S1) and manipulate button SW1 go to mode P07), if punching bag (while checking Boxer) or kicker arm (while checking Kicker/Soccer) is moving UP/DOWN and on the main board (depending on bag/arm position) HI – LO shows this would indicate that the sensor is working.
- 2 Check if sensor cable is firmly connected to the main board.
- 3 Check all wires to/from the sensor.

Halogen lights are not functioning:

- 1 Check power supply cable connection.
- 2 Check power supply wire integrity.
- 3 Check connector plug for loose bulb.
- 4 Check if halogen is not burned by swapping it with a new one (12V, 20W).

Button START or PLAYERS is not functioning:

- 1 Check for main board cable connection.
- 2 Check switch/button cable connection.

Computer power supply is not functioning:

- 1 Check if power supply cable is plugged in securely.

Power supply is refusing to work:

- 1 Check if “car” fuse in power supply is not burned (30A).
- 2 Check if transformer cable is correctly hooked up to power supply socket.

Machine is not starting:

- 1 Check power cable & fuse 5A.
- 2 Check if ON/OFF switch (filter) is not damaged.

Counter is showing Err:

- 1 Check if mechanical counter did not come loose (then turn the machine OFF and ON).

Bill Acceptor is not functioning:

- 1 Check if power supply cable is hooked up to main board (J3).
- 2 Check if cable from bill acceptor is correctly hooked up.
- 3 Check acceptor settings using switches: for switches 1-8 set 7 at ON, and for switches 1-4 set 3 & 4 at ON.

Sound is not working:

- 1 Check if it is not at low volume or mute (R362).
- 2 Check if cable is correctly connected to the main board.
- 3 Check if cable to speaker is correctly connected.

Red diode active on main board:

- 1 Usually caused by circuit being shorted at scale bulb array, check all cables for potential shortage.

Machine is showing 4.60 and restarts

- 1 Turn off the machine, take out the power ribbon cable and tighten all the pins inside the ribbon cable.
- 2 Take out the fuse green holders and tighten the metal clips.

10. Machine setup

Main Board Layout (Back Side)

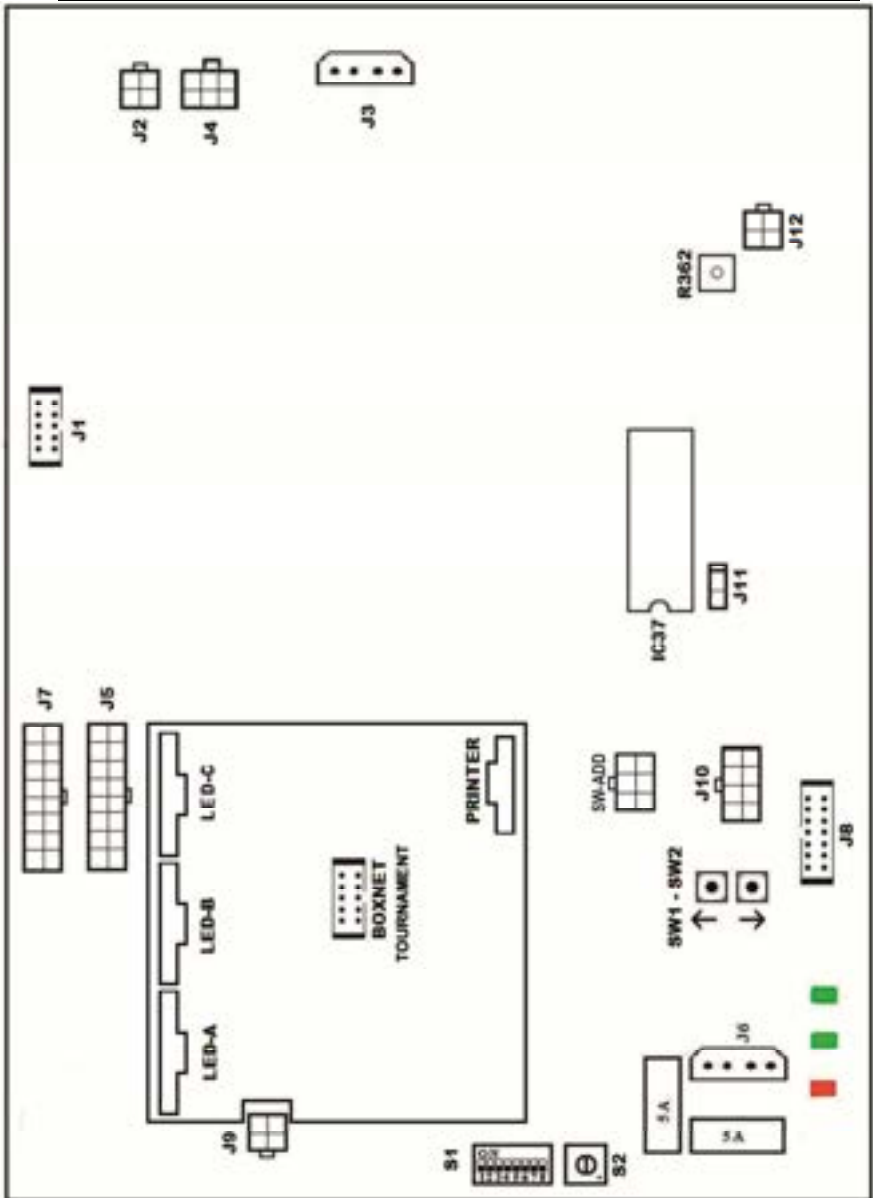

Drawing #1

List of connectors:

J1 – connector for coin acceptor

J2 – connector for bill acceptor

J3 – connector for power supply to bill acceptor, ticket dispenser, capsule dispenser, thermal printer

J4 - connector for ticket dispenser, capsule dispenser, thermal printer

J5 & J7 – front panel backlight

J6 – connector for main board power supply (12V supplied by AC power supply)

J8 – connector for power supply

J9 – sensor connector

J10 – connector for buttons PLAYERS and START BOXER

J11 – connector for mechanical counter

J12 – connector for speaker

SW-ADD – connector for START KICKER

S1 – service setting switches

S2 – step potentiometer for setting sensor sensitivity (0 – min, 9 - max)

SW1 & SW2 – help buttons (up/down)

R362 – potentiometer for volume control

IC37 – speech synthesizer

IC34 – main processor socket

LED-A - connector for Kicker power supply

LED-B - connector for Boxer and Kicker sensors

LED-C - connector for siren (optional)

PRINTER - connector for thermal printer

BOXNET/ TOURNAMENT - connector for BoxNet or BoxTournament for PC

LED-A and LED-B connectors



Dip Switch 1-8 (S1)

The switch box with 8 switches is located on the left side of the main circuit board. To program, switch #1 must be set to “ON” position when machine is ON.

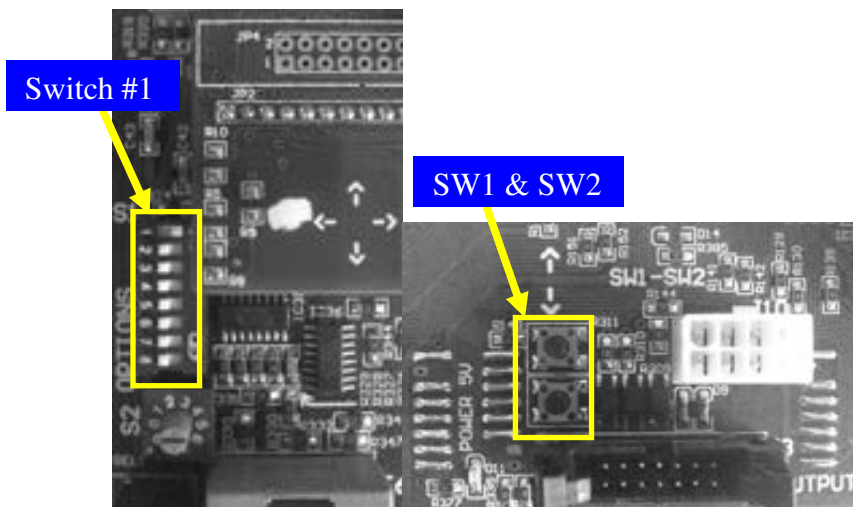

Push buttons SW1 ↑ and SW2 ↓ are located in the lower left part of the main circuit board.

Switch #1

Entering the program settings. Please use buttons SW1 ↑ or SW2 ↓ for finding the right program P1-P96. Descriptions for each program are listed below. During program selection you will see P1-P96 on the main display.

Remember, for setting you will use “START BOXING” (↑), “START KICKING” (↑) and “PLAYERS” (↓) buttons.

P1

Temporary counter of points. **1 point = \$.25 (25 cents).**

You can reset it to 0000 by pushing and holding the "START BOXING" button for 3 seconds.

P2

COUNTER OF POINTS. This is life long - not erasable.

P3

ELECTRONIC COUNTER OF REVENUE.

Counts the quarters while the mechanical counter is disconnected.

P4

CREDIT RATIO.

How many quarters (\$.25) is needed for 1 credit.

The left side of the ratio is controlled by the "START BOXING" button.

Example: 1 credit is worth four quarters (\$1), so the P4 will be set to 4 - 1.

1 credit is worth two quarters (50 cents), so the P4 will be set to 2 - 1.

NOTE: IF THE BILL ACCEPTOR IS SET 4 PULSES FOR A 1\$, SET P9 TO 12 (in case of the older software to 5).

P5

BONUS CREDITS.

You can set additional credits (bonus credits) when a set dollar amount is inserted. Using the "START BOXING" button you can adjust how many quarters received at once will give the bonus. Using the "PLAYERS" button you will then assign number of credits for the received amount.

Example: you want to set 8 credits (punches) for \$5, you should set P5 to 20-8. **NOTE: SEE RELATED SETTING P65.**

P6

BONUS CREDITS.

This setting functions the same as P5 **but always for bigger value of the bill or coin than P5.**

Example: if you want to set 8 credits (punches) for \$5, you should set P5 to 20-8.

if you want to set 18 credits (punches) for \$10, you should set P6 to 40-18. **NOTE: SEE RELATED SETTING P65.**

P7

SENSOR TESTING.

This function is used for testing of the sensor (diagnostic function).

When punching bag is in the vertical position - the display shows - "LO", when punching bag is in the horizontal position - display shows "HI".

EXAMPLE: If the display shows only “HI”, whether the punching bag is in vertical or horizontal position, probably the sensor is faulty. Contact your service.

P8

MAX POSSIBLE HIGH SCORE.

You can set the best score which will be on the display for **power mode** only. Players will never be able to receive a higher score (which must be set between **900** and **990**). You can adjust this value by using “START BOXING” (up) and “PLAYERS” (down) buttons. After you set the desired unattainable power high score you must turn **switch #5** to “ON” position.

IMPORTANT: after you set the record and put switch #5 to “ON” position, you must turn off the machine for 5 seconds.

P9

INTERNATIONAL SETTINGS.

This function is used for different settings of the coin acceptor, for example: 0-usa, 1-canada.

Note: if the bill acceptor is set 4 pulses for a 1\$, set p9 to 12 (in case of the older software to 5).

P10

PARAMETER USED BY FACTORY. DEFAULT SETTING IS 0.

P11

HOPPER OUTPUT DEVICE SETTINGS.

0 - OFF,

1 - TICKET DISPENSER,

2 - BALL DISPENSER,

3 - POWER ALWAYS ON (USED FOR THERMAL PRINTERS).

NOTE: in order to manually feed the ticket dispenser press and hold in the same time switch “SW1” and “SW2”.

Default setting is 3.

P12

TICKET DISPENSER – TICKETS.

Sets how many tickets will be given for 1 credit (range from 0-5, default setting 5).

P13

TICKET DISPENSER – TICKETS FOR HIGH SCORE.

Sets how many tickets for the highest score (range from 0-20, default setting 5).

P14

TICKET DISPENSER - "BREAKING POINT".

Setting that would enable the ticket dispenser to start giving out the tickets (range from 0-990). Factory setting is 0.

P15

TICKET DISPENSER – 1ST PAY-OUT

Sets how many tickets will be given out after reaching the "breaking point" as the first value (range from 0-20). Factory setting 0.

P16

TICKET DISPENSER – POINT INCREMENT.

Point increment, in another words - how many more points must be scored before the next ticket/s will be given out (range from 10-100). Factory setting 40.

P17

TICKET DISPENSER – NUMBER OF TICKETS.

Number of tickets given out after reaching each point increment – set in P16. Range 0-5, factory setting 0.

P18

COUNTER OF RELEASED TICKETS.

BELOW 2 EXAMPLES.

RESULT ON DISPLAY	TICKETS		RESULT ON DISPLAY	TICKETS
0	0		0	0
40	1		40	0
80	2		80	0
120	3		120	0
160	4		160	0
200	5		200	0
240	6		240	0
280	7		280	0
320	8		320	0
360	9		360	0
400	10		400	0
440	11		440	0
480	12		480	0
520	13		520	0
560	14		560	0
600	15		600	10
640	16		640	12
680	17		680	14
720	18		720	16
760	19		760	18
800	20		800	20
840	21		840	22
880	22		880	24
920	23		920	26
960	24		960	28
P14 = TICKET = 0			P14 = TICKET = 600	
P15 = TICKET= 0			P15 = TICKET = 10	
P16 = TICKET=40			P16 = TICKET = 40	
P17 = TICKET= 1			P17 = TICKET = 2	

P19

BONUS CREDITS FOR RECORD BREAKING.

You can set 0-10 bonus credits for breaking record (use the “START BOXING” button). Default setting is 1.

P20

CLEARING CREDITS.

You can clear the credits by pushing the “start boxing” button.

P21

COUNTER OF FREE PUNCHES.

You activate them by putting dip **switch #2** to “ON” position.

P22

COUNTER OF THE BROKEN RECORDS (HIGHEST SCORES).

Can be reset by pressing & holding “START BOXING” button.

P23

WINNING MODE SETTINGS.

0 - TWO WINNING PRIZES ARE POSSIBLE.

PRIZE #1 is for triple numbers such as 111, 222, 333...999.

PRIZE #2 is for multiples of 100 such as 100, 200, 300...900.

Note: Setting prize #3 is available in this mode but does not have any meaning and is reserved for future expansions.

1 – NOT USED.

2 – NOT USED.

3 – IN THIS MODE WINNING IS BASED ON A RANGE OF NUMBERS. **P59 TO P64 MUST BE SET.**

Example: Range Prize #1 is won when the score falls between the two numbers set in P59 and P60. Factory default setting for Range Prize #1 is between 900 and 950.

NOTE: In order to have a prove of winning the prize, thermal printer or ticket dispenser is recommended.

The machine will print ticket for the highest score (Power mode) as a Prize #4 if printer is installed.

	P24	P25	P26
IF P23 = 0	Set	Set	Don't Set
IF P23 = 1	Not used	Not used	Not used
IF P23 = 2	Not used	Not used	Not used
IF P23 = 3	Don't Set	Don't Set	Don't Set

P24

FREQUENCY OF WINNING - FOR PRIZE #1. THIS REPRESENTS THE NUMBER OF POINTS (QUARTERS) ACCUMULATED BEFORE THE POSSIBILITY OF WINNING THE PRIZE. REACHING THIS NUMBER DOES NOT GUARANTEE A WINNER, HOWEVER IT INCREASES THE CHANCES OF WINNING (RANGE 0-10000, DEFAULT SETTING 1200).

Example: If number is set to 100, for every 100 quarters (\$25) collected by the machine there will be one possibility of winning prize #1.

P25

FREQUENCY OF WINNING - FOR PRIZE #2. RANGE 0-10000, DEFAULT SETTING 800). SEE **P24**.

P26

NOT USED.

P27

THIS COUNTER REPRESENTS THE NUMBER OF POINTS (QUARTERS) COLLECTED FOR POSSIBILITY OF WINNING PRIZE #1 (CAN BE RESET BY PRESSING & HOLDING START BOXING BUTTON).

P28

COUNTER FOR NUMBER OF COLLECTED POINTS (QUARTERS) TOWARDS PRIZE #2 (CAN BE RESET BY PRESSING & HOLDING START BOXING BUTTON). SEE **P27**.

P29

NOT USED.

P30

INITIAL HIGH SCORE (RECORD) SETTING FOR POWER PUNCH. (Range 500-999, default setting 650). Use "START BOXING" to increase boxer initial record ("PLAYERS" to decrease the record) or "START KICKING" to increase kicker initial record ("PLAYERS" to decrease kicker record).

P31

NUMBER OF FREE CREDITS AWARDED FOR THE PRIZE #1.

Can be assigned using this option. This number can be set in the range of **0-50**, default setting: 1.

P32

NUMBER OF FREE CREDITS AWARDED FOR PRIZE #2.

Can be assigned using this option. This number can be set in the range of **0-50**, default setting: 1.

P33

NOT USED.

P34

NUMBER OF TICKETS GIVEN FOR PRIZE #1.

Can be assigned using this option. This number can be set in the range of 0-50, default setting: 5. Works for P23=0.

P35

NUMBER OF TICKETS GIVEN FOR PRIZE #2.

Can be assigned using this option. This number can be set in the range of 0-50, default setting: 10. Works for P23=0.

P36

NOT USED.

P37

COUNTER SHOWING THE NUMBER OF PRIZE #1 WINNERS.

Can be reset by pressing & holding “START BOXING” button. Works for P23=0.

P38

COUNTER SHOWING THE NUMBER OF PRIZE #2 WINNERS.

Can be reset by pressing & holding “START BOXING” button). Works for P23=0.

P39

NOT USED.

P40

THERMAL PRINTER – BREAKING POINT.

Setting of the lowest score (break point), for which the thermal printer installed on the machine will print a ticket (range 100-999, default setting 998). The printer should be set up to print the player’s score.

Note: this print out has a delay of 20-30 seconds.

P41

THERMAL PRINTER – PRINTING ON/OFF.

If set to ‘1’ the ticket from the thermal printer (if installed) will be printed for the highest score (prize #4).

If set to ‘0’ no ticket for the highest score will be printed.

Default setting: 1.

P42

THE FIRST MAGIC NUMBER - FREQUENCY OF WINNING.

(PRIZE #5). This represents the number of points (quarters) accumulated before the possibility of winning the first magic number prize (set in P43). Reaching this number does not guarantee a winner, however it increases

the chances of winning. Range 10-10000, skip count 10, default value 400.

P43

THE FIRST MAGIC NUMBER

Setting of the number itself (range 100-999, default value 777, the function is off when P43=0).

P44

THE FIRST MAGIC NUMBER - COUNTER OF POINTS.

Quarters collected for prize (prize #5). Can be reset by pressing & holding "START BOXING" button.

P45

THE FIRST MAGIC NUMBER - COUNTER OF PRIZE WINNINGS.

Counts how many times the first Magic Number Prize occurred. Can be reset by pressing & holding "START BOXING" button.

P46

NOT USED.

P47

NOT USED.

P48

NOT USED.

P49

HIGH SCORE DECREASE - CREDITS.

Number of credits inserted in the machine at one time which decreases the high score (in power mode). Range 0-50, default value: 0 (function is off).

P50

HIGH SCORE DECREASE – VALUE.

Value by which the highest score will be lowered (setting which works with P49, range 0-50, default value: 2).

P51

CAPSULE DISPENSER – BREAKING POINT ON/OFF.

If set to 1 activates option P52. Default setting: 0.

P52

CAPSULE DISPENSER – HIGH SCORE BREAKING POINT.

Setting of the high score (breaking point) above which surprise ball (capsule) will be dispensed.
(range 100-900, default setting: 500).

P53

CAPSULE DISPENSER – DISPENSED CAPSULES COUNTER.

Counter of dispensed surprise balls (capsules) (can be reset by pressing & holding “START BOXING” button).

P54

THE SECOND MAGIC NUMBER - FREQUENCY OF WINNING.

(PRIZE #6). This represents the number of points (quarters) accumulated before the possibility of winning the second magic number prize (set in P55) (range 10-10000, skip count 10, default value 400). Reaching this number does not guarantee a winner, however it increases the chances of winning.

P55

THE SECONDS MAGIC NUMBER.

Setting of the second magic number itself (range 100-999, default value 0).

P56

THE SECOND MAGIC NUMBER - COUNTER OF POINTS.

Quarters collected for prize (prize #6). Can be reset by pressing and holding “START BOXING” button for 10 seconds.

P57

THE SECOND MAGIC NUMBER - COUNTER OF WINNINGS.

Can be reset by pressing and holding “START BOXING” button for 10 seconds.

P58

NOT USED.

P59

RANGE PRIZE #1 - UPPER SCORE LIMIT

(RANGE 900-999, DEFAULT SETTING: 950).

NOTE: Settings in P59 to P64 cannot overlap. For example, if the lower limit for range prize #1 is 900, the upper limit for Range Prize #2 must be less than 900 and so on.

Important: this game mode is activated with P23 = 3.

P60

RANGE PRIZE #1 - LOWER SCORE LIMIT

(RANGE 851-999, DEFAULT SETTING: 900). SEE P59.

P61

RANGE PRIZE #2 - UPPER SCORE LIMIT

(RANGE 800-998, DEFAULT SETTING: 850). SEE P59.

P62

RANGE PRIZE #2 - LOWER SCORE LIMIT
(RANGE 751-998, DEFAULT SETTING: 800). SEE P59.

P63

RANGE PRIZE #3 - UPPER SCORE LIMIT
(RANGE 700-997, DEFAULT SETTING: 750). SEE P59.

P64

RANGE PRIZE #3 - LOWER SCORE LIMIT
(RANGE 100-997, DEFAULT SETTING: 700). SEE P59.

P65

ADDITIONAL CREDIT COUNT METHOD.

If set to 1 it will give out credit based on the total amount of money inserted before pressing the “START BOXING” button (if user inserts 5 singles credits will be counted same as five dollar bill, an extra credit will be given based on settings in option P5 and P6).

If set to 0 for each dollar inserted user will get one credit only. By default, the function is off (P65=0).

P66

SETTING OF BOXER ID.

This value can be changed by holding the “SW1” pressed and pressing “SW2” five times. This will allow changing the ID value with buttons “PLAYERS” and “START BOXING”. The range for this setting is 0 – 65000.

P67

BOXNET - TIME SETTING FOR SENDING INFORMATION.

Time is given in following format: HH.MM.SS, for example 05.25.00 means data from machine will be sent each 5 hours 25 minutes.

P67 = 0; function is off, no data is sent,

P67 = 00.00.05...00.01.00; cycle between sending info packets is 5 sec to 1 min (in 5 sec jumps),

P67 = 00.05.00...18.00.00; cycle between sending info packets is 5 min to 18 hours (in 5 min jumps).

When turning the machine on, the data is sent after first 3 minutes, despite P67's setting, in order to stabilize GSM connection (although no data is sent when P67=0).

After setting time in P67 machine has to be turned off and turned back on.

P68

SETTING FOR FLASHING LIGHTS IN IDLE STATE:

P68 = 0; OFF,

P68 = 1 to 60; minutes before lights start flashing. Default setting: 0.

P69

SETTING FOR SOUND DELAY IN IDLE STATE:

P69 = 0; OFF,

P69 = 1 to 60; minutes before sound starts playing. Default setting: 0.

NOTE: dip switch #3 will determine if sound will be played.

P70

AUTOPLAY – FREE GAME.

Setting time after which machine will release a free game.

P70 = 0; OFF,

P70 = 1 to 180; minutes before free game is activated. Default setting: 0.

P71

PRINT PRIZE #1

(**1 = print, 0 = don't print**). Default setting : 0. Works for P23=0 or P23=3.

P72

PRINT PRIZE #2

(**1 = print, 0 = don't print**). Default setting : 0. Works for P23=0 or P23=3.

P73

PRINT PRIZE #3

(**1 = print, 0 = don't print**). Default setting : 0. Works for P23=3.

P74

FACTORY SETTING.

P75

FACTORY SETTING.

P76

FACTORY SETTING.

P77

CAPSULE DISPENSER – 100 & 111 PRIZES ACTIVATION

Activation of surprise ball (capsule) dispenser when player reaches 100, 200, 300...900 points or 111, 222, 333... 999 points, as follows:

0 - the function if OFF,

1 - the surprise ball (capsule) dispenser is ON for multiples of 100 such as 100, 200 ...900 and for triple numbers such as 111, 222 ...999,

- 2 - the surprise ball (capsule) dispenser is on for multiples of 100 only,
 - 3 - the surprise ball (capsule) dispenser is on for triple numbers only.
- Default setting is 0 (OFF).

P78

CAPSULE DISPENSER – RECORD BREAKING

Activation of surprise ball (capsule) dispenser when player breaks the record (high scores in power mode). When set to 1 the function is ON, when set to 0 - it is OFF. Default setting: 0.

P79

CAPSULE DISPENSER - 100 PRIZE FREE CREDITS

Defines how many free credits will be given when player reaches a score of multiple of 100 (range 0-10, default setting: 0).

P80

CAPSULE DISPENSER - 111 PRIZE FREE CREDITS

Defines how many free credits will be given when player reaches a score of triple number (range 0-10, default setting: 0).

P81

RELAX

Time for which halogen lamp will be on (range 0-5 seconds), jump 0.1 second).

P81=0.0 - the function is OFF; halogen will not shine.

P81=0.1...5.0 - halogen shines.

- example: when P81=0.4 it means the halogen lamp will be on for 0.4 second.

Default setting is 0.0 – relax function is OFF.

P82

RELAX

Defines frequency of how often halogen lamp will not shine (range 1 second to 1 hour).

Time is given in following format: hh.mm.ss.

P82=00.00.01...00.00.10 (1 to 10 seconds, 1 second jump),

P82=00.00.10...00.10.00 (10 seconds to 10 minutes, 5 seconds jump),

P82=00.10.00...01.00.00 (10 minutes to 1 hour, 1 minute jump).

Default setting is P82=00.00.30 (30 seconds).

- example: when P82 is set to 10, every 10 seconds halogen will not shine (pause).

Important:

P82 can be set but it always has to be equal or higher value than P81.

- example: setting P81=4.5 and P82 00.00.01 cannot be done.

P83

NOT USED.

P84

CAPSULE DISPENSER – WINNING ASSISTANT (CREDITS)

Defines how many credits need to be received by the machine in order to activate assisting function set in P85 and to dispense capsule (range 0-999, default value 0). When set to 0 the function is OFF (capsules for multiples of 100 and triple numbers will be dispensed). When credit count is smaller than P84, no capsule will be dispensed. When credit count is bigger than P84, the capsules for multiples of 100 or triple numbers will be dispensed.

P85

CAPSULE DISPENSER – WINNING ASSISTANT (POINTS)

Activation of the function assisting in winning the surprise ball (capsule) set in **P77**. The setting defines the range of points, 0 to 10, which are being used to achieve the winning number. When set to 0 the function is OFF. Default value: 0 – no help scoring prizes. Setting 1 helps a little, 10 - helps the most.

P86

AUTOMATIC HIGH SCORE RESET (FREQUENCY)

Defines frequency of resetting high scores (time in hours). Available range is 0 to 240. If set to 0 then the function is OFF. Default value: 0.

Note: This time is calculated from the last resetting either automatic or manual (using the dip switch #4). Works with P87.

P87

AUTOMATIC HIGH SCORE RESET (IDLE STATE)

Defines for how long (time in minutes) machine needs to be in the idle state (not operated but turn on) for the scores to be reset. The limit of hours in P86 must be first met. Available range is 0 to 240. If set to 0 then the function is OFF. Default value: 1. Set it along with P86.

P88

PARAMETER USED BY FACTORY.

P89

NOT USED.

P90

CAPSULE DISPENSER – NUMBER OF GAMES

Number of games played after which a surprise ball will be given out (range 0 - 1000).

When P90=0 the function is OFF (games will not be counted up).

For the function to be effective P11=2.

Example: if number of games is bigger than P90, the capsule dispenser will give out a ball. After dispensing a ball, the game counter is reset.

P91

SIREN – RECORD BREAKING

Setting siren for record breaking. This sets the duration time of siren signal.

0 - the function is OFF.

1..20 - seconds for which siren will be ON (1 second skip).

P92

SIREN – BREAKING POINT TIME ON

Setting siren for breaking point. This sets the duration time of siren signal.

0 - the function is OFF.

1..20 - seconds for which siren will be ON (1 second skip). P93 need to be set.

P93

SIREN – BREAKING POINT

Setting the break point for siren.

0 - the function is OFF.

100..999 - breaking point. Default setting: 850. P92 needs to be set.

P94

SIREN - AFTER MONEY INSERT DURATION.

Sets the siren signal duration time after money insert.

0 - the function is OFF.

0.1..10 - seconds for which siren will be ON (0.1 second skip).

P95

SIREN – “START BOXING” OR “START KICKING” BUTTON RELEASE.

Sets the siren signal duration time after “START BOXING” or “START KICKING” release.

0 - the function is OFF.

0.1..10 - seconds for which siren will be ON (0.1 second skip).

P96

COUNTERS FOR NUMBER OF KICKER AND BOXER GAMES

Upper counter - kicker,

Lower counter - boxer.

To reset kicker game counter press “START BOXING” for 2,5 seconds.

To reset boxer game counter press “START KICKING” for 2,5 seconds.

P97

PUNCHING BAG RELEASE DELAY TIME FOR FREE GAME

Sets delay time for punching bag release in free game mode (with Switch #2 on ON).

0 – release delay is off;

[1..30] – time of release delay in seconds. Time is counted from the last release. Display shows the remaining time for the next available release.

Switch #2

WHEN “ON” MACHINE IS SET FOR FREE PUNCH/ KICK.

Switch #3

IF “ON” “DEMO” WILL PLAY EVERY 2 MINUTES, WHEN THE MACHINE IS NOT USED. IF “OFF” THE SOUND IS TURNED OFF.

Switch #4

WHEN “ON” THE HIGHEST SCORE FOR EACH GAME WILL BE RESET AFTER YOU PUSH THE “START BOXING” BUTTON. WHEN “OFF” THE TOP SCORES WILL STAY DISPLAYED.

Switch #5

WHEN “ON” YOU WILL ACTIVATE UNATTAINABLE RECORD (HIGHEST SCORE) WHICH YOU MUST SET BEFORE IN P08 (SERVICE KEY).

REMEMBER: TO ACTIVATE THIS RECORD YOU MUST TURN OFF AND TURN ON THE MACHINE.

Switch #6, #7

TURNING ON/OFF BOXER/KICKER GAMES.

WHEN BOTH SWITCHES #6 AND #7 ARE “ON” OR BOTH ARE “OFF”, BOTH GAMES ARE AVAILABLE (ON).

OTHER SETTINGS:

#6 “ON” AND #7 “OFF” - KICKER IS ON, BOXER IS OFF

#6 “OFF” AND #7 “ON” - KICKER IS OFF, BOXER IS ON.

DEFAULT SETTING IS #6 OFF AND #7 OFF.

GAME TYPE SWITCH NUMBER	KICKER	BOXER	KICKER & BOXER	
#6	ON	OFF	OFF	ON
#7	OFF	ON	OFF	ON

Switch #8 NOT USED

Sensitivity switch (S2).

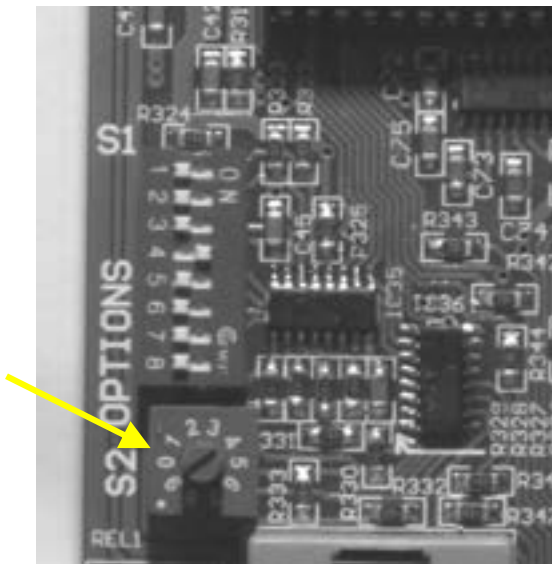

The sensitivity can be changed by rotating switch S2. After the switch is rotated the sensitivity level will be shown on the credit display. Lower level numbers correspond to greater difficulty. Default setting is 5.

Main Board Layout (Front)

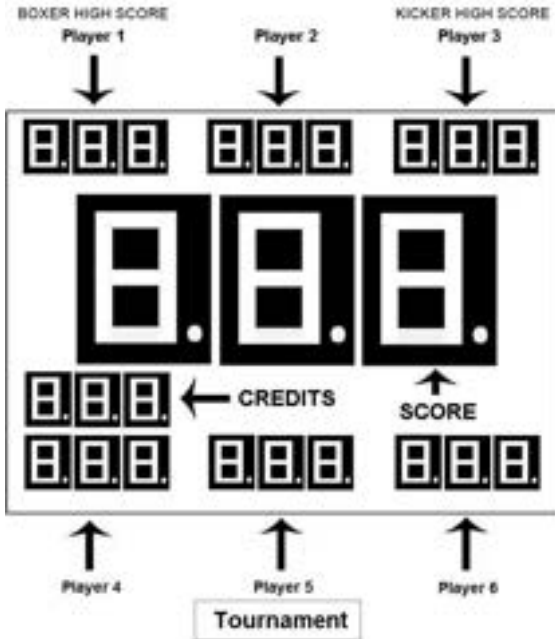

Drawing #2

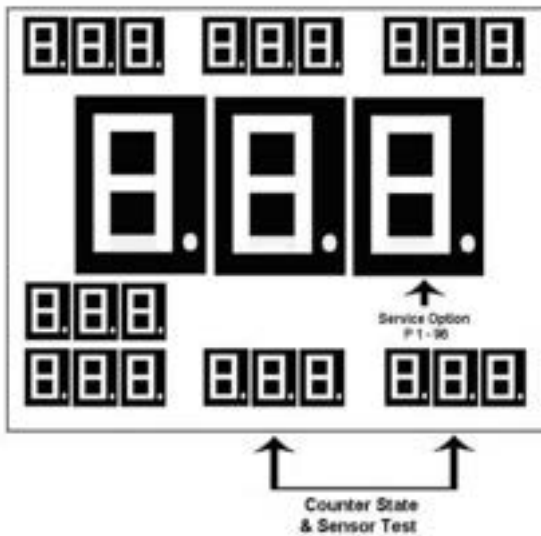

Drawing #3

Boxer Power Supply Layout:

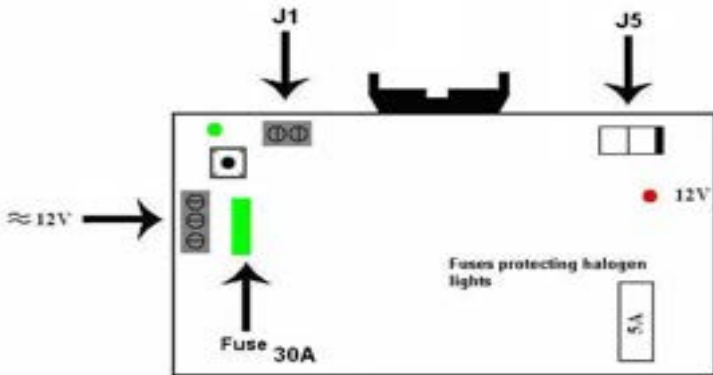

Drawing #4

Kicker Power Supply Layout:

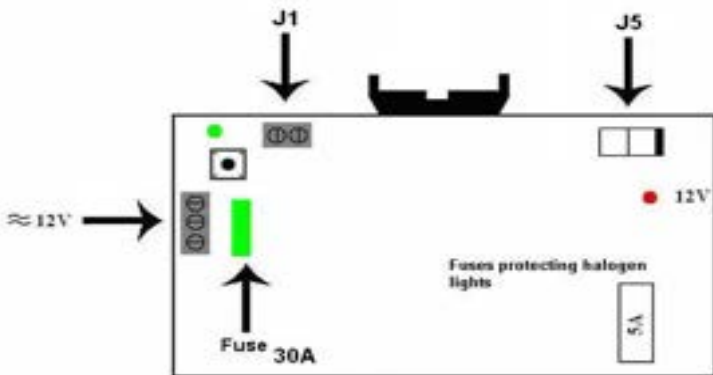

Drawing #5

Main Power Supply Layout:

Front view

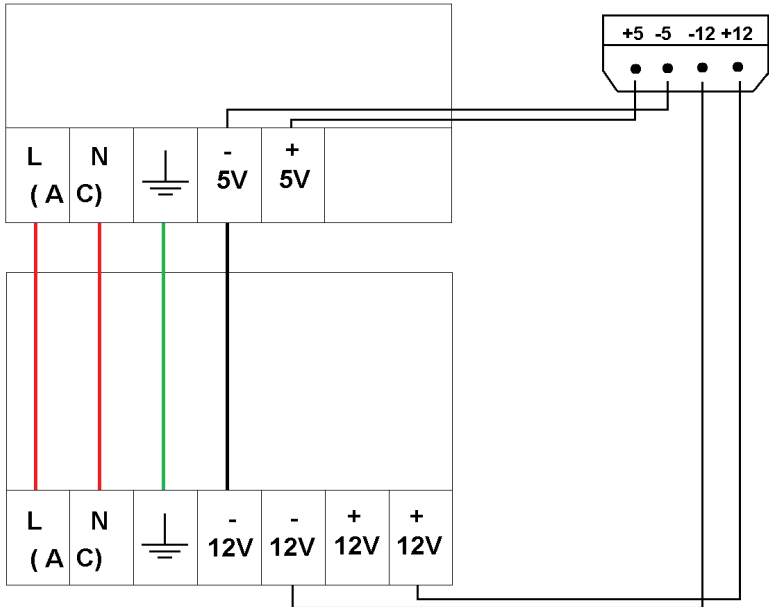

Drawing #6

Mechanical counter

2 – wire from mechanical counter

1 – wire from mechanical counter

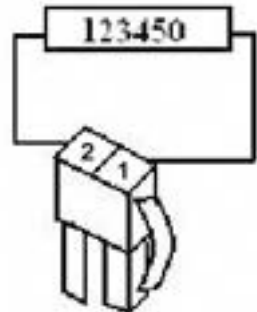
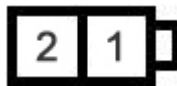

Drawing #7

Sensor

- 1- Emitter
- 2- Cathode
- 3- Anode
- 4- Collector

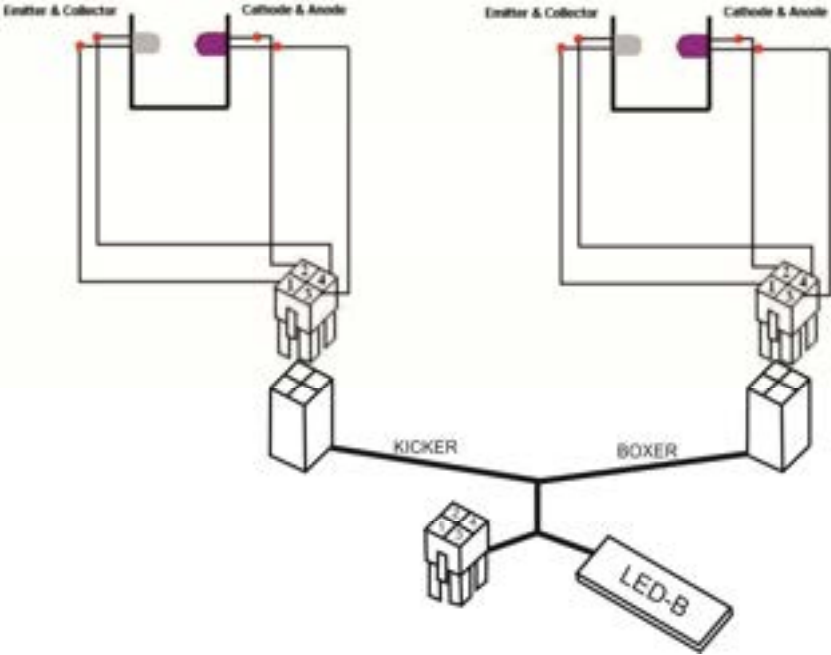
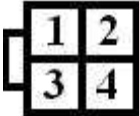

Drawing #8

Speaker

- 1 - speaker
- 2 - speaker
- 3 - unused
- 4 - unused

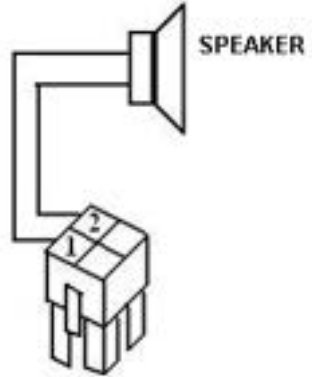
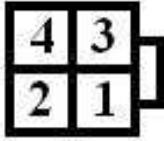

Drawing #9

Buttons Start Boxing & Players

- 1 & 2 – START game (Boxer)
- 3 & 4 – player selection
- 5 & 6 – bulbs lighting button Start
- 7 & 8 – bulbs lighting button Game

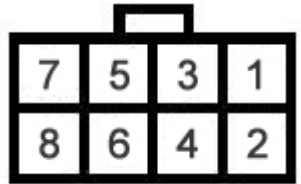

SW-ADD

- 1 & 2 – START game (Kicker)
- 5 & 6 – bulbs lighting button Start

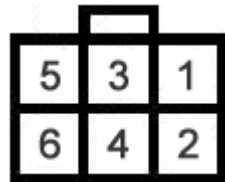

J4

Ticket dispenser

- 2 - red (+12V)
- 6 - green (signal)
- 3 - black (-12V)

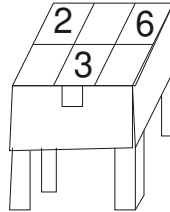

Drawing #10

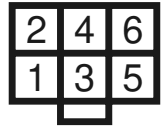

Hopper

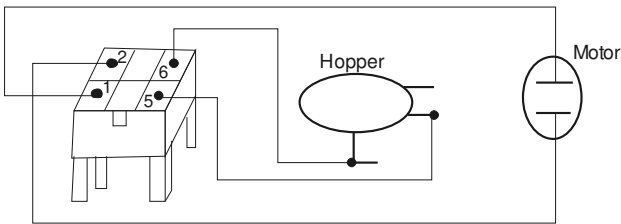

Drawing #11

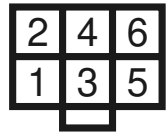

Thermal printer

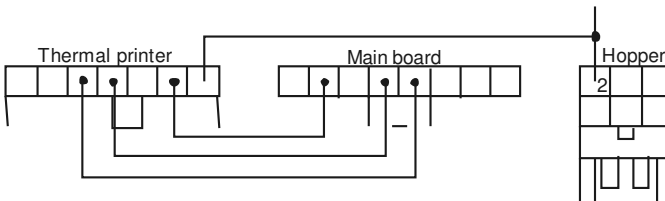

Drawing #12

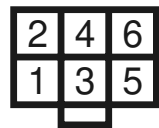

J5

- 1 – tournament (-)
- 2 – tournament (+)
- 3 – 100 (-)
- 4 – 100 (+)
- 5 – 300 (-)
- 6 – 300 (+)
- 7 – 500 (-)
- 8 – 500 (+)
- 9 – 700 (-)
- 10 – 700 (+)
- 11 – 900 (-)
- 12 – 900 (+)
- 13 – Select Game (-)
- 14 – Select Game (+)
- 15 – Force (-)
- 16 – Force (+)

2	4	6	8	10	12	14	16
1	3	5	7	9	11	13	15

J7

- 1 – 100 (-)
- 2 – 100 (+)
- 3 – 300 (-)
- 4 – 300 (+)
- 5 – 500 (-)
- 6 – 500 (+)
- 7 – 700 (-)
- 8 – 700 (+)
- 9 – 900 (-)
- 10 – 900 (+)
- 11 – Select Game (-)
- 12 – Select Game (+)
- 13 – not used
- 14 – not used
- 15 – power Kicker (-)
- 16 – power Kicker (+)

2	4	6	8	10	12	14	16
1	3	5	7	9	11	13	15

Paper Money Depositor

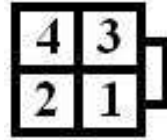

1 – Credit relay (Common) normally purple.

Pin#8 at the ICT connector

2 – +12V (Power) normally red. Pin#5 at the ICT connector

3 – GND (Power) normally orange. Pin# 9 at the ICT connector

4 – Credit relay (N.O) normally blue. Pin# 7 at the ICT connector

11. Spare parts and equipment

- leveling legs 4 pieces
- punching bag pump 1 piece
- bladder 1 piece

12. Standard replacement parts

- 1 bladder
- 1 pump for bladder
- 2 rubber feet

13. Required tools and equipment for servicing the boxing game

- Metric wrench set from 8mm to 19mm (preferably with ratchet)
- Long Allen wrench from 8mm to 19mm
- Snap ring pliers for inside diameters
- Phillips and flat screwdrivers
- Glue gun
- Volt meter
- Bag inflator (supplied with the machine)
- Pliers
- Wire stripper
- Hook and loop (Velcro) stripes
- Plastic wire ties

14. Step by step setup and maintenance instructions

HOW TO ACCESS QUICKLY RESETABLE (P1) AND NOT RESETABLE (P2) MONEY COUNTERS

P1 and P2 counters can be checked (at the same time) without going into service program, by pressing SW1 ↑ button. The SW1 button is located in the lower left part of the main board, right above ribbon cable connecting main board with side power supply (small board). The displayed numbers will appear for 30 seconds. During that time counter P1 can be reset by pressing and holding SW1 button for 3 seconds (after resetting machine will switch to regular work mode).

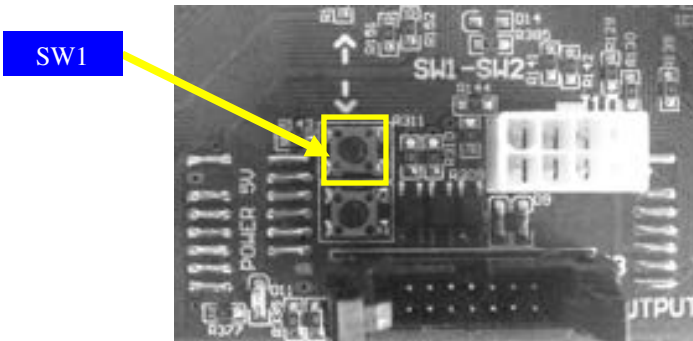

HOW TO ACCESS QUICKLY RESETABLE (P1) MONEY COUNTER (without opening the machine)

P1 counter can be displayed without using service functions or opening the back doors by pressing and holding **START BOXING** and **PLAYERS** buttons in the same time for 5 seconds. The P1 counter will be appear for 15 seconds.

HOW TO TEST COIN OR BILL ACCEPTOR

The test of bill and coin acceptor can be done without changing the meter reading by pressing and holding **START BOXING** and **PLAYERS** buttons in the same time for 5 seconds. On the main display P1 will appear. At that time bills and coins can be inserted for a test. After inserting every single coin (bill) testing time will be extended for another 15 seconds. If the testing mode is not used for 15 seconds, machine will switch to regular working mode.

HOW TO SET-UP PRICE OF THE GAME.

Enter the settings mode by powering up the machine and switching DIP switch #1 to ON position.

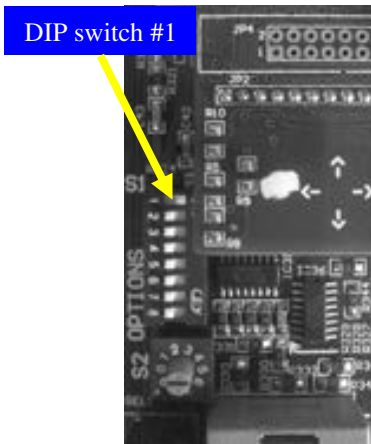

The main display should now indicate the settings mode with **'P 1'** as shown.



Press the **SW1** button repeatedly on the main board until the main display reads '**P 4**'. If you get too far on this menu you can always get back with the **SW2** button.

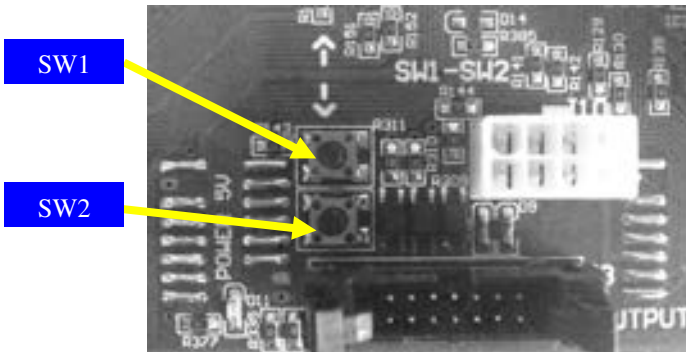

Now you can modify the setting to set-up the price of the game (if one game credit is to cost \$1 the setting would then be 4-1, meaning that 4 quarters equals one punch). There is one number you must set here and this is done by the machine's **START BOXING** button in the front. After you are done the display should look like the following picture if you chose these settings.



To leave the settings mode simply turn the DIP switch #1 to OFF (left) position.
The machine should reset and be ready to go.

HOW TO SET UP BONUS POINTS

Enter the settings mode by powering up the machine and switching DIP switch #1 to ON position.

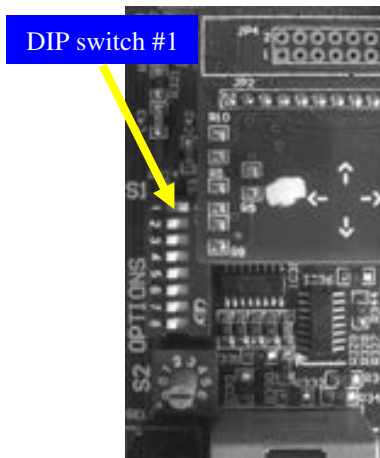

The main display should now indicate the settings mode with 'P 1' as shown.



Press the **SW1** button repeatedly on the main board until the main display reads 'P 5'. If you get too far on this menu you can always get back with the **SW2** button.

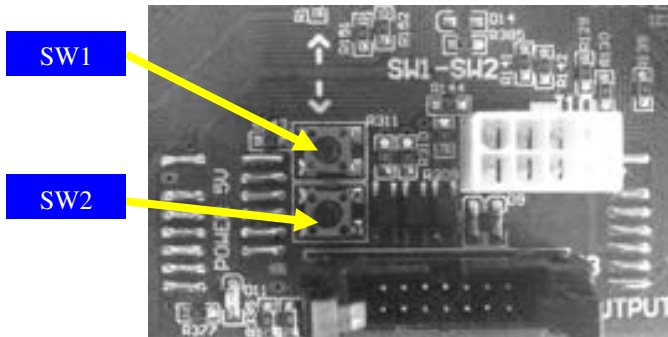

This setting corresponds to the number of credits given when a set dollar amount is put in the machine. For example: you want to set 8 credits (punches) for \$5 ($5 \times 4 = 20$ quarters), you should adjust this setting to indicate 20-8 as shown.



The values can be set using **START BOXING** and **PLAYERS** buttons. As shown, **START BOXING** sets the left value and **PLAYERS** sets the right value. Repeat the procedure for 'P 6' but remember to set the bonus for a larger amount of money than in 'P 5'. Example could be 20 credits for \$10, ($10 \times 4 = 40$, so the setting is 40-20). If you get too far while increasing these values, you must continue going up to 100 before you again end up at single 0. To leave the settings mode simply turn the DIP switch #1 to OFF (left) position. The machine should reset and be ready to go.

HOW TO SET UP MAGIC NUMBER

The magic number can be any 3 digit combination. The magic number as well as the frequency of hitting that number must be set. Enter the settings mode by powering up the machine and switching DIP switch #1 to ON position.

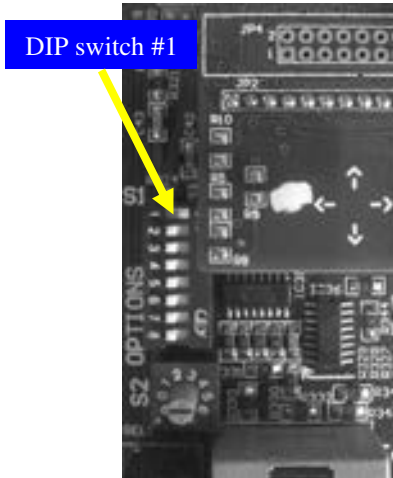

The main display should now indicate the settings mode with **'P 1'** as shown.



Press the **SW1** button repeatedly on the main board until the main display reads **'P43'**. If you get too far on this menu you can always get back with the **SW2** button.

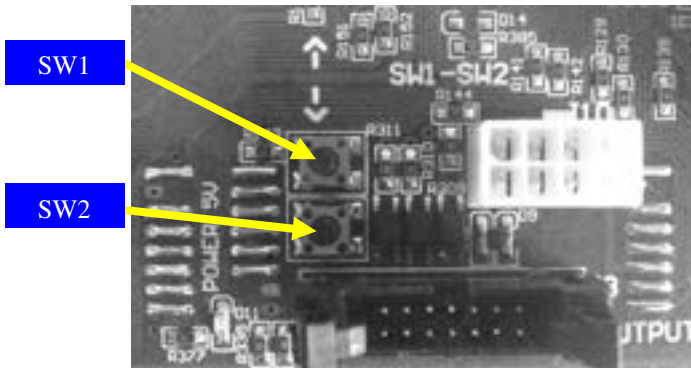

Use the **START BOXING** and **PLAYERS** buttons to adjust the value of the magic number as desired. Press the **SW2** button to get to setting 'P42', which is the minimum amount of credits collected by the machine to unlock the possibility of hitting that number. Here again use the same buttons to adjust the value. Remember that this value is counted in quarters. In this example the machine collects \$100 before unlocking the magic number (400 quarters = \$100). It becomes possible then for the player to hit the bag and get a score of '777'. The two pictures illustrate the magic number setting for this case.



To leave the settings mode simply turn the DIP switch #1 to OFF (left) position. The machine should reset and be ready to go.

HOW TO RESET HIGH SCORES MANUALLY

If you feel the score on the game reached an unbeatable number, you can reset this score to the default value (see setting P30). Enter the reset mode by powering up the machine and switching **DIP switch #4** to **ON** position.

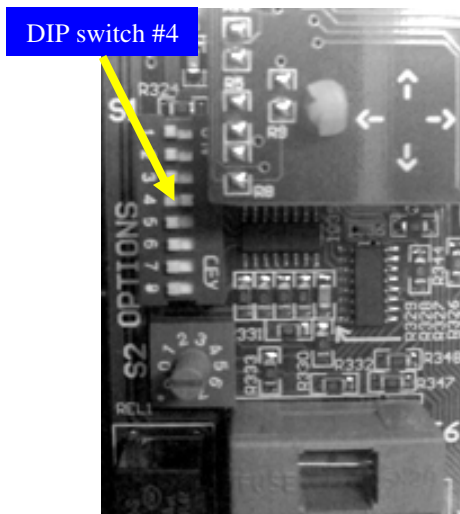

You will not see any changes on the display and the game will remain in playable mode. This is why it is important to remember to switch the machine back from this mode when done resetting. Next, press and hold the **START BOXING** button on the machine for about 10 seconds. When the score resets on the main display then release the **START BOXING** button and put **DIP switch #4** back to **OFF** position.

HOW TO RESET HIGH SCORES AUTOMATICALLY

If you want the machine to automatically reset the highest score (of Power Mode) so that it does not get too high, follow the instructions below.

The highest score will be reset to the value programmed in setting P30 (see setting P30).

Enter the settings mode by powering up the machine and switching DIP switch #1 (on the main board) to ON position.

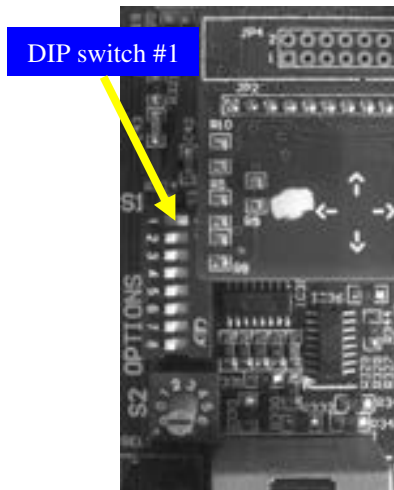

The main display should now indicate the settings mode with 'P 1' as shown.



Press the **SW1** button repeatedly on the main board until the main display reads '**P86**'. If you get too far on this menu you can always get back with the **SW2** button.

Using **START BOXING** button on the front of the machine set number of hours (counted from the last resetting) after which the highest score should be reset automatically, eg. set 120.



Then press the **SW1** button once - the main display should read '**P87**'. Using **START BOXING** button on the front of the machine set number of minutes (counted when machine is in idle state after the time set in P86 above has already passed) after which the highest score will be reset, eg. 15. Put DIP switch #1 back to OFF.



SUMMARY: With above settings the machine will count 120 hours from the last resetting (either manual or automatic), and then, if machine is in idle state for more than 15 minutes the highest score will be reset.

HOW TO ERASE CREDITS

Erasing the game's credits can be done with the following procedure. Enter the settings mode by powering up the machine and switching DIP switch #1 to ON position.

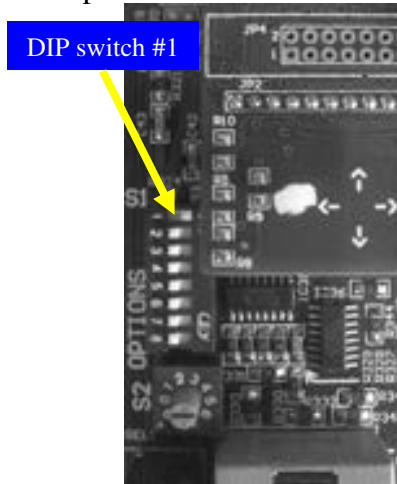

The main display should now indicate the settings mode with 'P 1' as shown.



Press the **SW1** button repeatedly on the main board until the main display reads 'P20'. If you get too far on this menu you can always get back with the **SW2** button.

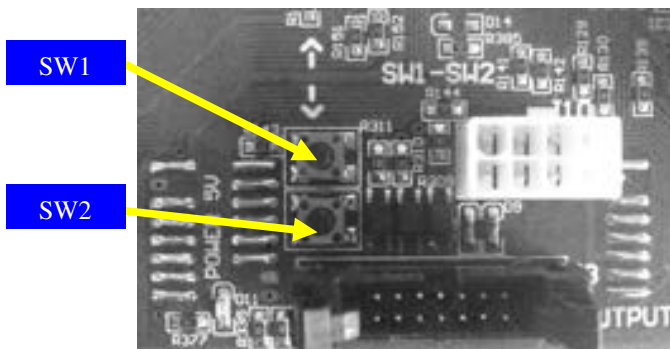

Press the **START BOXING** button located in the front of the game. When finished don't forget to set DIP switch #1 back to OFF position.

HOW TO CHANGE THE PUNCHING BAG

Changing the punching bag is required in some cases. Lower the bag arm as in the play mode and ready to punch. Take off the front guard and unscrew the top nut using 19 mm wrench (use wrench with a ratchet). This will release the bag assembly.

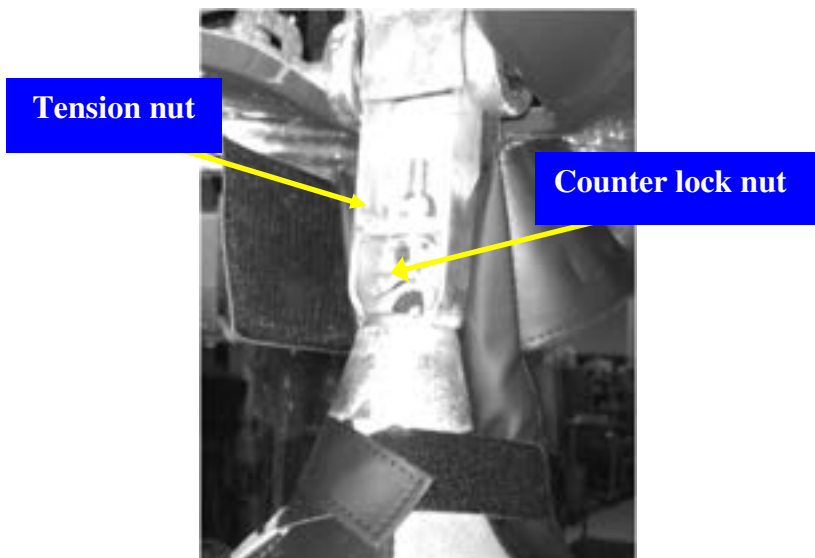

To install a new bag first make sure that the tension nut is taken off and the second nut is screwed all the way on the bolt. Otherwise the second

bolt will prevent the bag from properly tightening of the assembly. Insert the bag in its place, replace the tension nut and tighten it until the bag cannot be twisted by manual tests. To test this grab the bag in your arm and simply use your body's weight to try to twist the bag on the bolt's axis.



If it is secured tight enough, then finish by unscrewing the second nut until it tightens on the metal arm.

HOW TO RELEASE THE PUNCHING BAG MANUALLY

Sometimes it is necessary to release the punching bag when the machine has no power. This can still be done manually. You must reach over the bag and find the mechanical hammer holding the entire arm in position. Then using your thumb press the hammer which is under compression by a spring behind it and the bag should be free to come down.

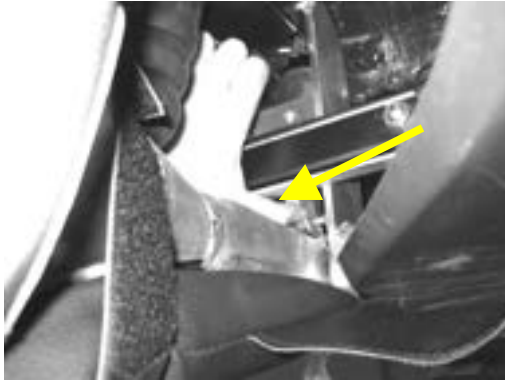

HOW TO CHANGE THE FUSE IN THE MAIN SWITCH

Locate the power cord connection on the back of the machine. The fuse can be found hidden between the power cord socket and the main ON/OFF switch. In order to replace it use a flat screwdriver to pry open the fuse holder and pull it out.



HOW TO CHECK THE SOLENOID

Proper operation of either of solenoids can be verified by releasing the punching bag (when checking Boxer) or kicker/soccer arm (when checking Kicker/Soccer) electronically. This can be done by first pressing by pushing a release button located on the side power supply (not the main board). Each power supply is labeled, if you want to check punching bag, press the button on power supply labeled “Boxer”, if you want to check kicker/soccer arm, press the button on

power supply labeled “Kicker”. Power up the machine and press this button. If the bag is released the solenoid is working.



If the bag does not come down there may be a problem with the solenoid. Remove the two solenoid wires connected to the power supply circuit board. Unscrew the two terminals and pull these wires out.

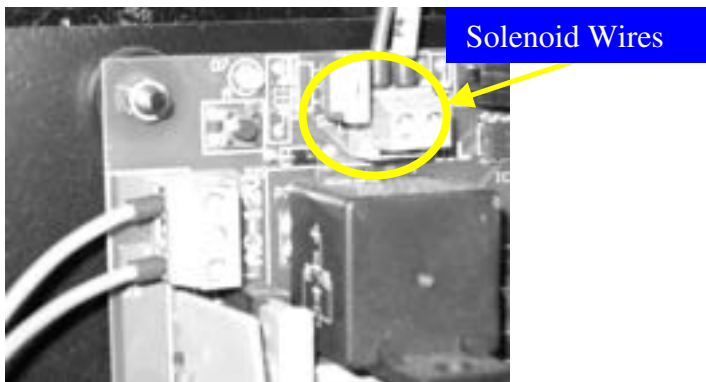

Check resistance on these two terminals with a multi-meter. The resistance should be very low around 0.5 Ω . If your meter shows overload or infinite resistance the solenoid coil may be damaged. In that case replacing the solenoid is necessary.

The solenoid can be evaluated in another way if for example you do not have a multi-meter handy. This also involves unscrewing the two terminals and pulling out the two wires. Instead of measuring the resistance as described above make a temporary connection with direct

12 V supply by touching the two wires onto the input voltage terminal as shown in the picture below.

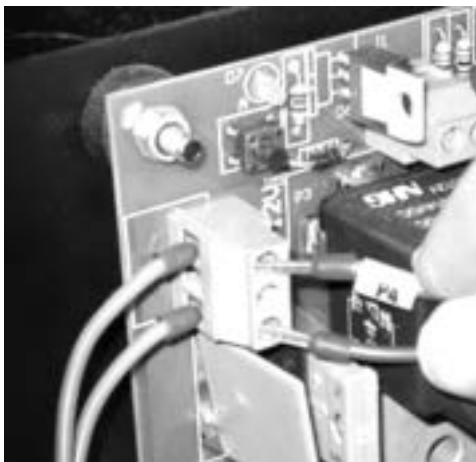

MAIN BOARD SETTINGS

P1		P31		P61	
P2		P32		P62	
P3		P33		P63	
P4		P34		P64	
P5		P35		P65	
P6		P36		P66	
P7		P37		P67	
P8		P38		P68	
P9		P39		P69	
P10		P40		P70	
P11		P41		P71	
P12		P42		P72	
P13		P43		P73	
P14		P44		P74	
P15		P45		P75	
P16		P46		P76	
P17		P47		P77	
P18		P48		P78	
P19		P49		P79	
P20		P50		P80	
P21		P51		P81	
P22		P52		P82	
P23		P53		P83	
P24		P54		P84	
P25		P55		P85	
P26		P56		P86	
P27		P57		P87	
P28		P58		P88	
P29		P59		P89	
P30		P60		P90	

MAIN BOARD SETTINGS

P91					
P92					
P93					
P94					
P95					
P96					

MAINTENANCE LOG	Date of Service					
	Punching bag condition					
	Punching bag pressure					
	Arm protector condition					
	Arm protector position					
	Legibility of disclaimer					
	Legibility of instruction					
	Level of machine					
	Grease on mechanism					
	Bulbs					
	Buttons					
	Bill and coin validators					
	Safe condition (Yes/No)					
	SERIAL NO	If not working or condition not safe for use what was replaced				
Comments						
Signature						

MAINTENANCE LOG	Date of Service					
	Punching bag condition					
	Punching bag pressure					
	Arm protector condition					
	Arm protector position					
	Legibility of disclaimer					
	Legibility of instruction					
	Level of machine					
	Grease on mechanism					
	Bulbs					
	Buttons					
	Bill and coin validators					
	Safe condition (Yes/No)					
SERIAL NO	If not working or condition not safe for use what was replaced					
	Comments					
	Signature					